



**CREATIVE DESIGN MFG.**  
A wholly-owned subsidiary of Jay Scotts, USA

# 69505- TOULAN

Note:  
The height and width of legs

Item	Height (Inch)	Width (Inch)
69505.28	0.4	1.75
69505.23	0.4	1
69505.18	0.25	1.25
69505.36	0.5	1.25
69505.15	0.25	1
69505.11	0.25	1

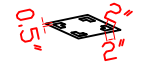
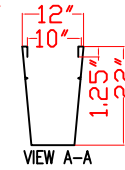
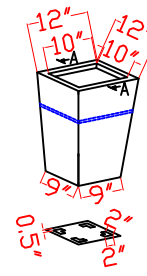
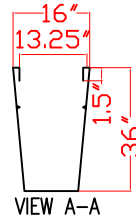
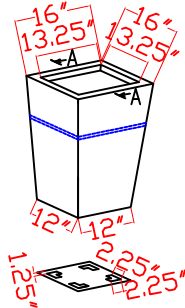
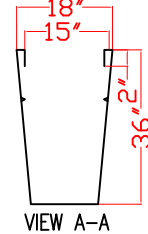
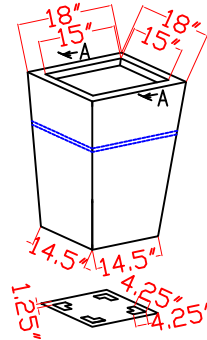
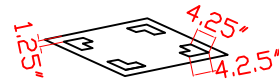
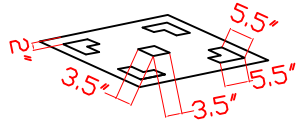
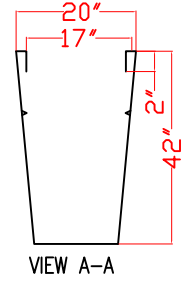
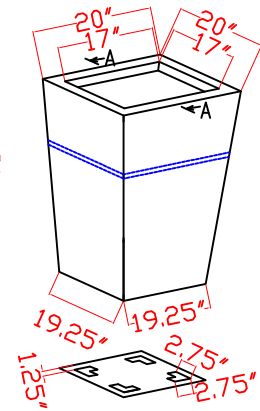
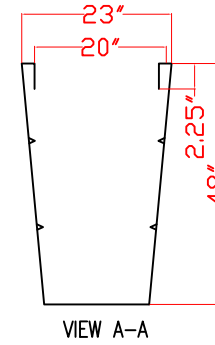
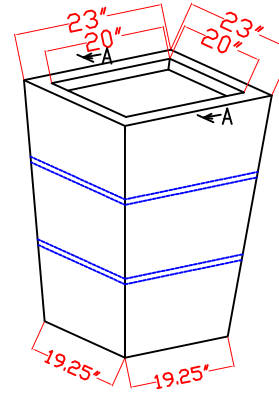
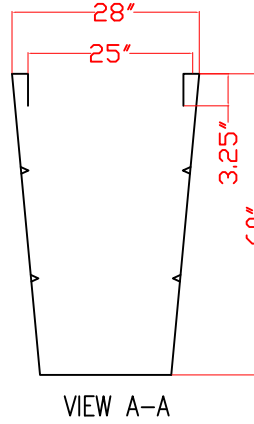
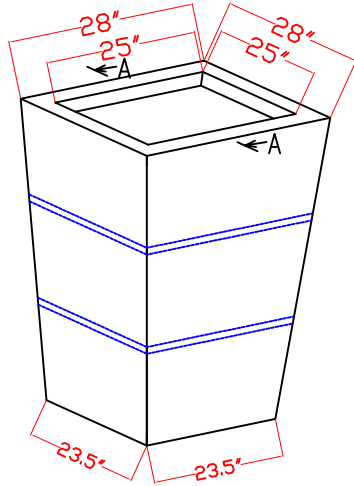

Item	Surface Area (m <sup>2</sup> )	Weight (Kg)
69505.11	0.88	4.5
69505.15	1.45	9.0
69505.18	2.42	14.6
69505.23	3.36	21.0
69505.28	4.99	31.1
69505.36	2.01	11.6